

# PRECISION DRIVE SYSTEMS

*HIGH SPEED SPINDLES,*

*TOOLING, & ACCESSORIES*

*FOR MACHINES & ROBOTS*



ROBOTIC  
APPLICATIONS



WOOD, PLASTIC,  
LIGHT ALLOYS,  
COMPOSITE MATERIALS

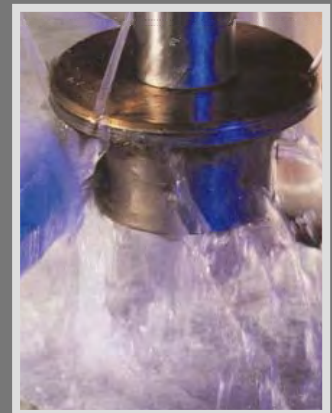

STONE, MARBLE,  
GRANITE, GLASS

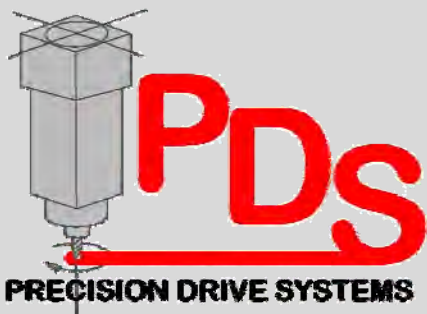

# THE COMPANY

**Precision Drive Systems, LLC** was founded in 1996 as the only North American center for sales and service authorized by Giordano Colombo of Carate Brianza, Italy. PDS saw a need in the U.S. market that was not being satisfied for OEM's and users of CNC routers and Robotic Systems . The proper selection, application, repair, and maintenance of electric spindles used in a broad range of production demands could not conveniently, quickly or economically be realized from the factories located in Europe. In March, 2005, **Precision Dynamic Spindles GmbH** was founded to provide the same reliable service to the European marketplace.

We take pride in providing quality goods and services at a fair price while responding quickly to our customers needs. We keep a **substantial inventory of new and rebuilt electric spindles, spare parts, frequency drives, tooling, aggregates, multi-spindle boring units, collets and accessories** on hand in North Carolina and Bad Oyenhausen, Germany. We are fully capable of modifying and customizing Colombo spindles to configure them for constant torque or constant power, different voltage levels, and different speed ranges. Our new spindles carry a *twelve-month factory warranty*.

## Giordano Colombo History:

Our partner company, Elettromeccanica Giordano Colombo s.r.l. was founded in Carate Brianza, Italy in 1956. The founder, Giordano Colombo, developed a special motor winding procedure for electric machines and frequency generators that would later make the company a world leader in the production of asynchronous three-phase electric spindles and frequency converters. Today, with more than fifty years of experience, the company's product line, distribution network and technical expertise have grown in a managed fashion to meet and exceed customer expectations.

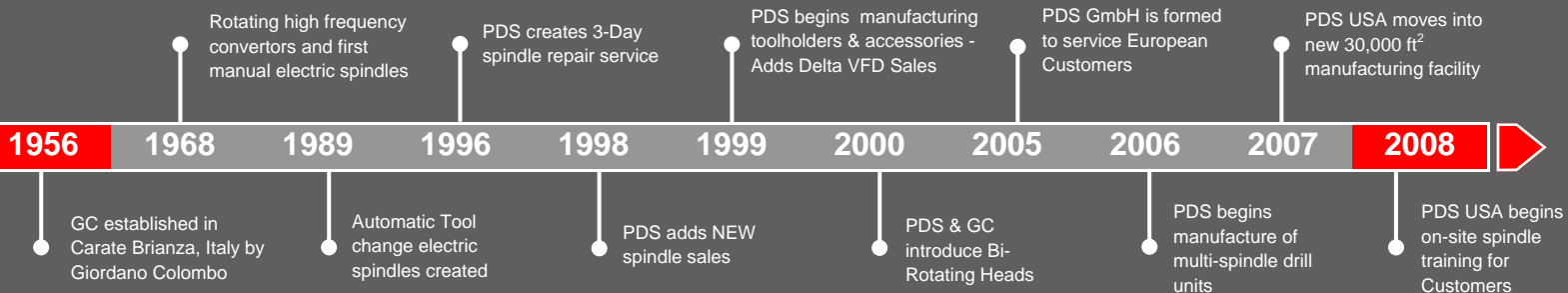

## INNOVATION

From the very beginning, both Colombo and PDS have been synonymous with innovation. From Giordano Colombo's advances with electrical spindle windings, automatic tool change systems, and Bi-Rotating heads to PDS's toolholder and boring unit designs, the focus of our company has always been to stimulate the market with customer driven innovations.

## QUALITY

The first goal of PDS and all of our chosen suppliers is to produce a high quality and reliable product.

Our products are produced and repaired in clean rooms to insure that contaminants are kept out of our work. Spindles undergo rigorous run-in tests and are balanced to over 3 times better than the industry standard.

## FLEXIBILITY

One of the greatest features of PDS is the flexibility to provide the customer with a product that is specific to their application. We are able to customize the spindle to different voltages, speeds, cooling methods, and tool clamping to fit the customers needs. Flexible manufacturing allows us to produce both small and large quantities of a particular spindle type while maintaining a reasonable delivery period.

# SPINDLE SERVICE

Our spindle repair centers include world class clean rooms staffed by Colombo factory trained spindle repair technicians. PDS' technical staff is highly skilled in diagnostic spindle failure analysis, dynamic balancing, precision bearing preload, assembly, thermal dynamics, and quality assurance to uphold factory specifications. Our standard spindle repair service takes 3 business days from estimate approval and we offer an emergency 24-hour service at an additional charge. Our spindle repairs always carry a six month factory warranty

Spindle repair and rebuilding is conducted in our facility for all makes and models of machine tool spindles. Standard spindle repairs are typically completed in 3-4 days. Emergency 24hr service is available as an option on PDS Colombo brand Spindles.

- Our facility includes a temperature and humidity controlled clean room to keep dust and contaminants out of your spindles and errors out of our work.
- Our equipment is state of the art to insure accurate results.
- Our technicians and managers are factory trained to insure quality.
- 6 Month Warranty on Repairs (12 Months for NEW spindles)
- Free Inspections, diagnosis, and quotations
- Genuine factory parts are used (no reworking of old parts)



## REPAIR PROCESS

- Spindle is securely packaged and shipped to Precision Drive Systems

Attn: Spindle Repair Department  
Precision Drive Systems  
4367 Dallas Cherryville Highway  
Bessemer City, NC 28016 USA

- The spindle is disassembled, evaluated and a free quotation is provided for the repair parts, labor and testing.
- Customer approval of the free estimate is required before any spindle repair effort begins.
- Standard spindle repairs are typically completed in 3-4 days after approval of the repair costs.
- Every rebuilt spindle is subjected to our stringent run-in procedures including concentricity validation and precision balancing in all 4 planes and a six hour dynamic test which includes incremental speed increases at hourly intervals with data recordings at each interval.
- Spindle passes all testing and is prepared for shipment. Shipping methods vary according to customer preference.

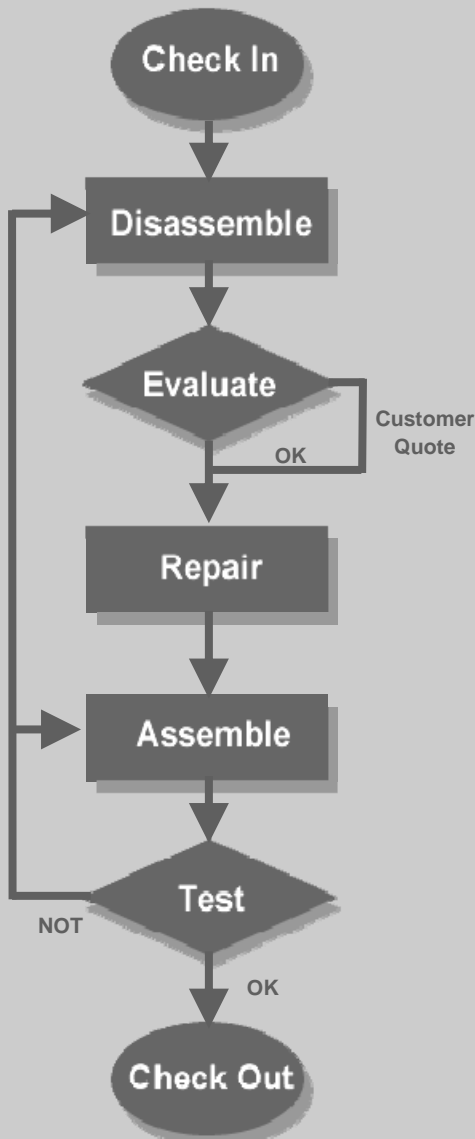

# TECHNICAL GUIDE

The electric spindle is the heart of the machine tool. Correct spindle selection is imperative for optimum machine performance. This guide is to help you select the most suitable spindle for your application. PDS Colombo spindles are offered with over 150 types ranging from 1/4 to 40 HP and speeds up to 60,000 RPM. We feel sure we are able to meet your needs. PDS will help you select Electric Spindles, Frequency Inverters, Tool Holders, Multi-Spindle Drill Units, and Aggregate Drives.

Your choice of spindle comes from considering many different variables such as: type of material, cuts, tool geometry, feed rates, and spindle speed. Detailed information is available to calculate these factors, but our guide below may help.

## Application and Materials:

- Engraving or cutting plastic, plywood or fiberboard up to 1/4" thick and below 500 ipm feed rate, use spindles around 1.5 to 5 HP with operating speeds up to 40,000 rpm. Their small size and weight also make them highly maneuverable to suit small routers and robots with 5 axis or 3-D carving capabilities.
- Cutting wood, plastic or aluminum using straight tools below 3/4" diameter at feed rates around 300 to 600 inches / minute, use spindles between 5 and 10 HP with operating speed ranges of 12,000 to 24,000 rpm.
- Heavy-duty demands including large profile tools over 1" diameter at high feed rates of 500 to 3000 ipm in high-density materials (e.g., phenolic, hardwood or aluminum), use higher power spindles with 10 to 40 HP and operating speed ranges from 9,000 to 24,000 rpm.

MATERIAL TYPE	FORM	RV	RS	RC	RA
Nickel Alloyed Steel	Sheets	Red	Red	Yellow	Yellow
Stainless Steel (300 Series)	Sheets	Red	Red	Yellow	Yellow
Stainless Steel (400 Series)	Sheets	Red	Red	Yellow	Yellow
Carbon Alloyed Steel	Sheets	Red	Red	Yellow	Yellow
Mild Steel	Sheets	Red	Red	Yellow	Yellow
Stone, Granite & Marble	Blocks & Slabs	Red	Red	Yellow	Green
Composite Fibers (Carbon, Graphite)	All	Yellow	Yellow	Green	Green
Aluminum & Light Alloys	All	Yellow	Yellow	Green	Green
Phenolics & Fiberglass	Sheets & Molded	Yellow	Yellow	Green	Green
Polycarbonate Rigid Plastic	Sheets	Yellow	Yellow	Green	Green
Solid Hardwoods, Oak, Maple, Ash	All	Green	Green	Green	Green
Plywood & OSB	Sheets	Green	Green	Green	Green
Solid Softwoods, Pine, Fir, Birch	All	Green	Green	Green	Green
Flexible Plastic & PVC	Sheets & Pipes	Green	Green	Green	Green
MDF (Medium Density Fiberboard)	Sheets	Green	Green	Green	Green
Particle Board	Sheets	Green	Green	Green	Green
Rigid Foam (Vitrified Plastic)	Blocks and Molded	Green	Green	Green	Green



NOT SUITABLE



USE CAUTION -  
CONSULT PDS



NORMAL APPLICATION RANGE

## SPINDLE SPEED

Incorrect spindle speed is a common error in CNC machining. Generally, each material and cut has an ideal tool profile and cutting speed. Larger diameter tools require slower speeds. Spindle speed and feed rate for a given cut must be balanced for best work quality, tool life and spindle life. Speed of the spindle is controlled by a FREQUENCY INVERTER. All spindles are 3-phase asynchronous motors with infinitely variable speed from 0 RPM to the Maximum rated RPM. This can be achieved by correctly programming your frequency inverter drive to match the spindle.

## FEED RATE

The feed rate of the machine must be balanced with the spindle speed. Changing one influences the other. Feed rates that are too slow decrease tool life due to overheating and may leave burn marks on the work. Heat builds in the tool when not enough material is removed to cool the cut interface. Often, determining the best feed rate can only come from trial and error. The general feed rate chart for different materials is shown as a starting point. Your cutting tool supplier can advise the cutting data for your specific application.

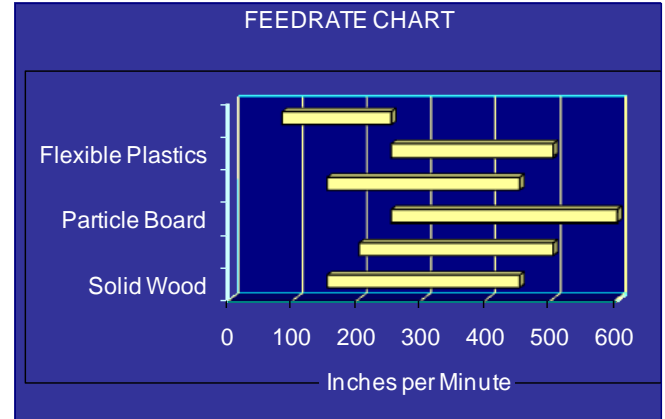

MATERIAL	CHIP LOAD	INCHES
	Minimum	Average
Solid Wood- dense	0.006	0.015
Solid Wood - soft	0.008	0.02
Particle Board	0.010	0.025
MDF	0.008	0.015
Rigid Plastic	0.010	0.02
Flexible Plastic	0.015	0.025
Aluminum	0.002	0.009

## CHIP LOAD

The inches feed per tooth (also called chip-load) determines the amount of stock that will be removed by each tooth (or flute) for a single revolution. If the chip load is too low for the material being cut, the chips will be very fine like dust and a lot of heat will be generated. If the chip load is too high for the material, the machine will push the cutter through the material rather than cutting it. This will result in high axial loads on the spindle bearings and eventual front bearing failure. See the chart to the left for generic chip load data.

$$\text{ChipLoad} = \frac{\text{FeedSpeed} (\text{in./min.})}{\text{RPM} \cdot N}$$

$$\text{RPM} = \frac{\text{FeedSpeed} (\text{in./min.})}{\text{ChipLoad} \cdot N}$$

## CUTTING ENTRY ANGLE

For the first mm of cut depth, decrease to 20% of normal feed rates. Ramp down to full cut depth at an angle less than about 20 degrees. This minimizes axial force. Above all, avoid "crashes" of the spindle into the table, fixtures, or work. Your spindle bearings are rated for high radial (side-cutting) loads and low axial (end cutting) loads. We offer other spindles for heavy boring duty for drilling many holes larger than 5/8" diameter.

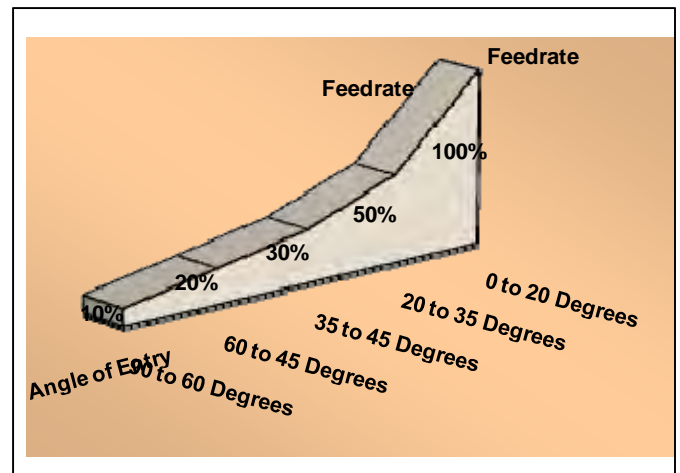

# TECHNICAL GUIDE

## Cleaning:

Keep spindle housing, fans and ductwork clear of debris to allow free movement of cooling air. Clean tool tapers, collet cavities, shafts and collets clean using denatured alcohol. Never use lubricants or oils on tooling items. Failure to keep tooling clean can cause tool misalignment, out of balance, tool slip and poor quality cuts.

## Warm Up:

Do not apply loads to a cold electric spindle. Before commencing work, run the spindle at 9,000 rpm for 10 minutes **OR** until the spindle bearing supports reach 98° F (human body temperature). This allows bearings, supports and the shaft to reach their designed dimensions through thermal expansion. Applying loads to a cold spindle will cause premature bearing failure. See the following page for a more in-depth Warm up procedure

## Cool Down:

Allow cooling system (fan, compressed air or liquid) and bearing pressurization (if fitted) to run for 10 minutes after stopping work. This minimizes condensation and prevents contaminants from being drawn into the bearing cavities.

## Tooling:

Keep tools sharp to reduce forces, heat and to maintain cut quality. Monitor increases in electric current to the spindle to detect loss of tool sharpness. Heat generated from tools can overheat bearing grease, evaporate its essential components and lessen bearing life. Maximum bearing temperature of bearing supports is 150° F. Excess heat will cause tool holders to jam in automatic tool change spindles. Be sure all spindle sensors operate properly to avoid damage. **CAUTION:** All PDS Colombo spindles are designed to accept only ISO or HSK tool holders. BT tool holders are not interchangeable.

Use only balanced tools and tool holders and rebalance all tools after each sharpening. Vibration from unbalanced tools can rapidly destroy bearings. The balance standard for tooling is 1.0 g (ANSI 1940/1). Replace any worn, scratched or deformed tool holders and collets with new items to prevent tool slip and imbalance from run-out. Consider optional vibration sensors now available. Normal collet wear life is < 700 hours. Tool slip leads operators to over tighten collet nuts and damage threads.

## Tooling Dimensions and Dynamic Limits

Spindle Taper	Clamping Force	Spindle Speed (rpm)	Maximum Tool Diameter (mm)	Maximum Tool Weight (kg)	Maximum Tool Length (mm)
HSK 63 - F	11,000 N (2475 lb)	6000 to 9000	250	10	150
		9000 to 12000	170	7	150
		12000 to 15000	130	5	150
		15000 to 18000	80	5	125
ISO 30 Heavy Duty (FB3)	5,000 N (1,125 lb)	6000 to 9000	140	5	150
		9000 to 12000	130	5	150
		12000 to 15000	110	3	150
		15000 to 18000	80	3	125
ISO 30 Medium Duty (FP1)	3,500 N (785 lb)	6000 to 9000	140	4	125
		9000 to 12000	130	4	125
		12000 to 15000	110	2.5	100
		15000 to 18000	80	2.5	75
ISO 25	2,100 N (475 lb)	6000 to 9000	120	3	*
		9000 to 12000	90	2.5	*
		12000 to 15000	60	2	*
		15000 to 18000	30	1.5	*
ISO 20	1,800 N (405 lb)	6000 to 9000	60	2.5	*
		9000 to 12000	40	2	*
		12000 to 15000	30	1.5	*
		15000 to 18000	20	1	*
ISO 15	835 N (190 lb)	6000 to 9000	50	2	*
		9000 to 12000	30	1.5	*
		12000 to 15000	20	1	*
		15000 to 18000	10	0.5	*

\* Consult PDS regarding your specific application

# PRODUCTS

Quality, Performance, and Reliability are the “Key Words” that define PDS Colombo products.

- Manual Tool Change electric spindles are available with many different cooling methods, tool receptacle types, speed ranges and power ranges. This versatility in different models allows for economic solutions for light environments along with high performance spindles for extreme environments.
- Automatic Tool Change electric spindles optimize machines and minimize production times while also provide a high degree of reliability. PDS Colombo offers the widest available range of automatic tool change spindles, covering the entire market from small very high speed spindles for engraving and plastics machining to large spindles for machining light alloys for the aerospace and automotive industries.
- Bi-Rotating Heads are available in four different versions for a broad application range. Stiffness, positioning accuracy, and power are the main features of the PDS Colombo bi-rotating heads. Equipped with special ATC spindles designed for 5-axis operations, our heads are available with different servo motor solutions and the option of continuous “C” axis rotation for maximum performance and reliability.
- Mechanical spindles are used in low speed, high power applications such as sanders and moulders. PDS Colombo mechanical spindles are available with HSK63-F tool clamping and a low center distance to get the spindle closer to the work piece.
- Aggregate Drives allow for horizontal or “4th axis” machining capabilities on three axis machines. Aggregates are available in many different forms including fixed angle, variable angle, and floating head styles. Grease or Oil bath lubrications allow for medium or high duty applications
- Multi-Spindle drill units are available in many standard configurations for your drilling and boring needs. Both Inline and L- shaped housings are offered with vertical and/or horizontal drills. All drills turn the same direction for decreased bit costs and each drill is activated independently.
- Variable Frequency Drives from Delta are ideal for high speed spindle applications with power ranges up to 40 HP and maximum frequencies of 1000 Hz. Single phase input up to 5 HP spindles.
- Accessories: PDS realizes that a highly accurate electric spindle is rendered useless if high quality toolholders and collets are not used; therefore we manufacture our accessories to some of the most stringent tolerances in the industry to insure optimal fit and balance.

## PRODUCT INDEX

### Manual Tool Change Electric Spindles

RV	8
RS	9
RC/RCE	10
RA	11



### Automatic Tool Change Electric Spindles

RV	13
RS	14
RC	15
RA	16



### 2 Axis Bi-Rotating Heads

INDEX-120	17
COMPACT	17
TP	18
FAST	18



### Mechanical Drive Spindles

SAT14	19
-------	----



### Processing Aggregates

FIXED	20
VARIABLE	20
FLOAT	21
C-AXIS	22



### Multi-Spindle Boring Units

BU	23
DRAWINGS	24

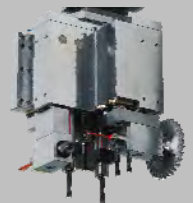

### Variable Frequency Drives

VFD - B	25
---------	----



### Accessories

ACCESSORIES	26
-------------	----



MTC

ATC

2AX

MDR

PA

BU

VFD

ACC.

# ELECTRIC SPINDLES

*Equipped with manual tool change system (MTC)*

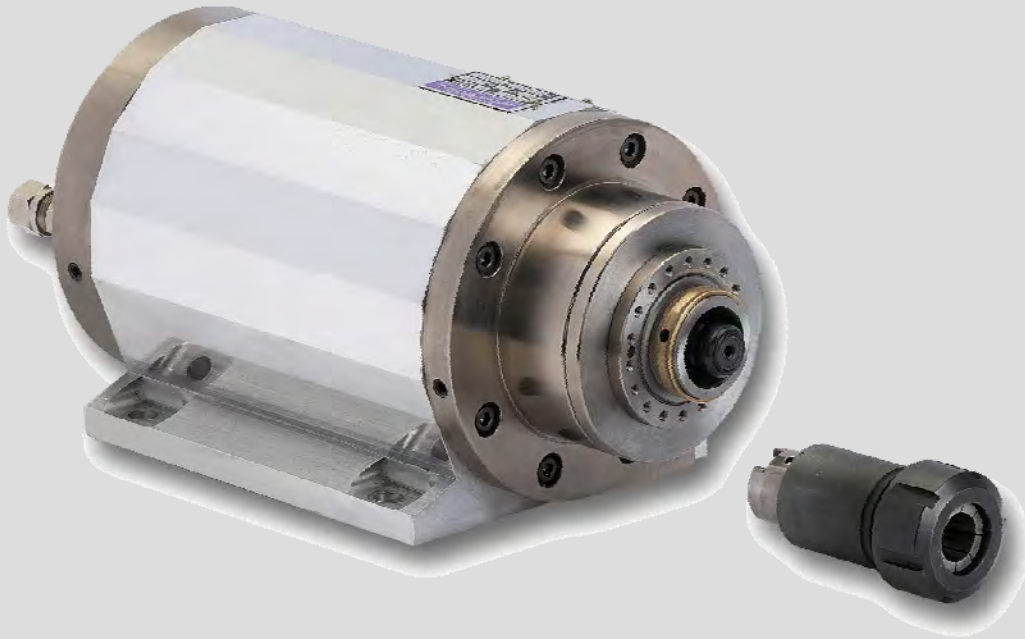

**PDS Colombo manual tool change electric spindles** are designed for applications in wood working, plastics, aluminum, light alloys, stone, marble, and glass. They are suitable for milling, boring, grinding, and flanging.

The wide range of power (from 0.4 HP to 40 HP), with rotating speeds up to 60,000 RPM, allow for the flexibility of use in many different applications. The spindles are capable of working in both the axial and radial directions.

The spindle housing is made from either an extruded aluminum bar, heat treated—special alloy aluminum ingot, or cast aluminum.

The spindle bearings are precision angular contact type bearings, with either steel or ceramic balls and they are lubricated for life with special grease designed for high speeds.

<b>Series</b>	<b>Description</b>
RV	Air Cooled by Shaft Driven Fan
RS	Air Cooled by Electric Fan
RC	Compressed Air Cooled
RCE	Compressed Air Cooled with Extruded Housing
RA	Liquid Cooled

# RV SERIES

# Air Cooled by Shaft Mounted Fan - MTC



For versatile use on woodworking, plastic, and light alloy machine tools. RV series manual tool change spindles are equipped with an axial fan that is directly fitted on the spindle shaft and provides the proper air volume for cooling via rotation of the spindle shaft.

Made from either extruded or cast aluminum closed frames, they achieve a protection rating of IP54 or superior with compressed air pressurization of the front bearing labyrinth seals.

Radial or angular contact bearings (also available with ceramic balls) provide rigidity, stiffness, and the capability of rotation speeds up to 24,000 rpm.

All rotating parts undergo dynamic balancing to stringent levels (residual unbalance values less than G0.4 according to ISO/UNI 1940/1) to minimize vibrations.

MODEL	HP RANGE		RPM RANGE	WEIGHT (LBS)	TOOL RECEPTACLE			
	S1 DUTY 100%				DIN 6499/B ER COLLETS	DIN 228-2 MORSE TAPER	DIN 69893-1 HSK-C	HYDRO
<b>RV42</b>	0.27 - 0.6		12,000 - 24,000	3 - 4	ER 11			
<b>RV55</b>	0.5 - 1.5		9,000 - 24,000	7 - 9	ER16 / ER20			
<b>RV73</b>	0.5 - 3		3,000 - 24,000	11 - 18	ER20 / ER25			
<b>RV90</b>	0.94 - 7.5		3,000 - 24,000	18 - 33	ER25 / ER32	N.2	HSK 40C	Ø 25 MM
<b>RV110</b>	3 - 10		3,000 - 24,000	48.5	ER25 / 32 / 40	N.2 / N.3	HSK 40C / 50C	Ø 25 MM
<b>RV116</b>	3 - 10		3,000 - 24,000	55	ER32 / ER40	N.2 / N.3	HSK 40C / 50C	Ø 25 MM
<b>RV120</b>	4 - 13.5		3,000 - 24,000	40 - 62	ER32 / ER40	N.2 / N.3	HSK 40C / 50C	Ø 25 MM
<b>RV135</b>	4 - 17.5		3,000 - 24,000	66 - 86	ER32 / ER40	N.2 / N.3	HSK 50C / 63C	Ø 25 MM
<b>RV154</b>	4 - 17.5		3,000 - 24,000	84 - 95	ER32 / ER40	N.2 / N.3	HSK 50C / 63C	Ø 25 MM
<b>RV170</b>	4 - 17.5		3,000 - 24,000	57 - 88	ER32 / ER40	N.2 / N.3	HSK 50C / 63C	Ø 25 MM

• Available in 2 pole or 4 pole. Single voltage and dual voltage configurations available. (ex. 220/380 or 230/460)

# RS SERIES

# Air Cooled by Independent Electric Fan - MTC

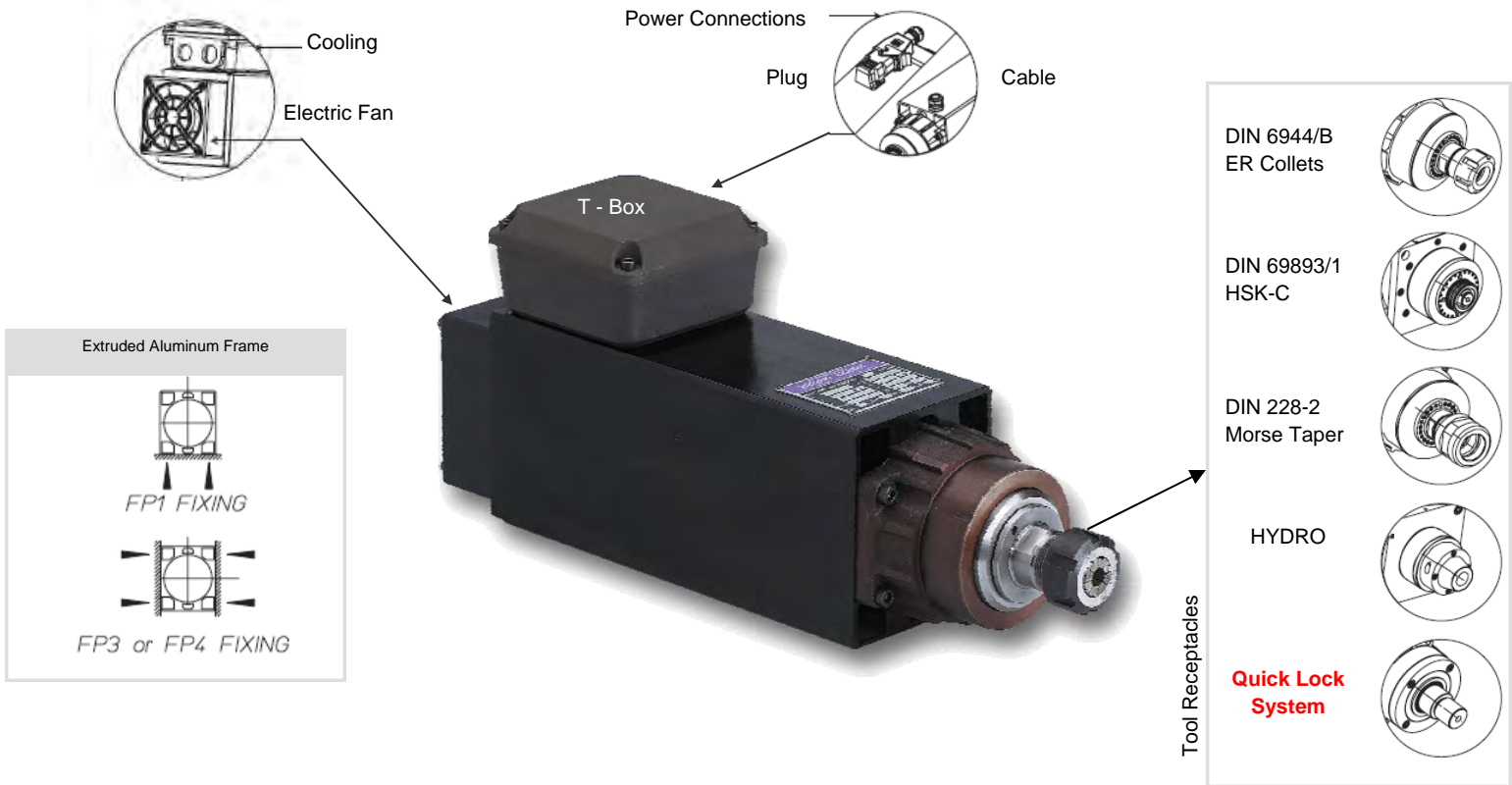

For versatile use on woodworking, plastic, and light alloy machine tools. RS series manual tool change spindles are equipped with an independent electric fan that is mounted directly on the spindle housing. The electric fan allows for the correct air flow for cooling at any speed (even when the spindle is not rotating) and also provides a much quieter solution than the RV series.

Made from either extruded or cast aluminum closed frames, they achieve a protection rating of IP54 or superior with compressed air pressurization of the front bearing labyrinth seals.

Radial or angular contact bearings (also available with ceramic balls) provide rigidity, stiffness, and the capability of rotation speeds up to 24,000 rpm.

All rotating parts undergo dynamic balancing to stringent levels (residual unbalance values less than G0.4 according to ISO/UNI 1940/1).

**The RS90 spindles are available with Quick-Lock clamping systems. This system allows for quick tool changing with no wrenches or collets needed.**

MODEL	HP RANGE	RPM RANGE	WEIGHT (LBS)	TOOL RECEPTACLE			
	S1 DUTY 100%			DIN 6499/B ER COLLETS	DIN 228-2 MORSE TAPER	DIN 69893-1 HSK-C	Quick Lock
RS55	0.5 - 1.5	9,000 - 24,000	7 - 9	ER16 / ER20			
RS73	1.5 - 3	3,000 - 24,000	11 - 18	ER20 / ER25			
RS90	3 - 7.5	3,000 - 24,000	18 - 33	ER25 / ER32	N.2	HSK 40C	Quick Lock 1/4,
RS110	7.5 - 10	3,000 - 24,000	48.5	ER25 / 32 / 40	N.2 / N.3	HSK 40C / 50C	
RS120	8 - 13.5	3,000 - 24,000	40 - 62	ER32 / ER40	N.2 / N.3	HSK 40C / 50C	
RS135	10 - 17.5	3,000 - 24,000	66 - 86	ER32 / ER40	N.2 / N.3	HSK 50C / 63C	

- Available in 2 pole or 4 pole. Single voltage and dual voltage configurations available. (ex. 220/380 or 230/460)

# RC-RCE SERIES

# Compressed Air Cooled - MTC

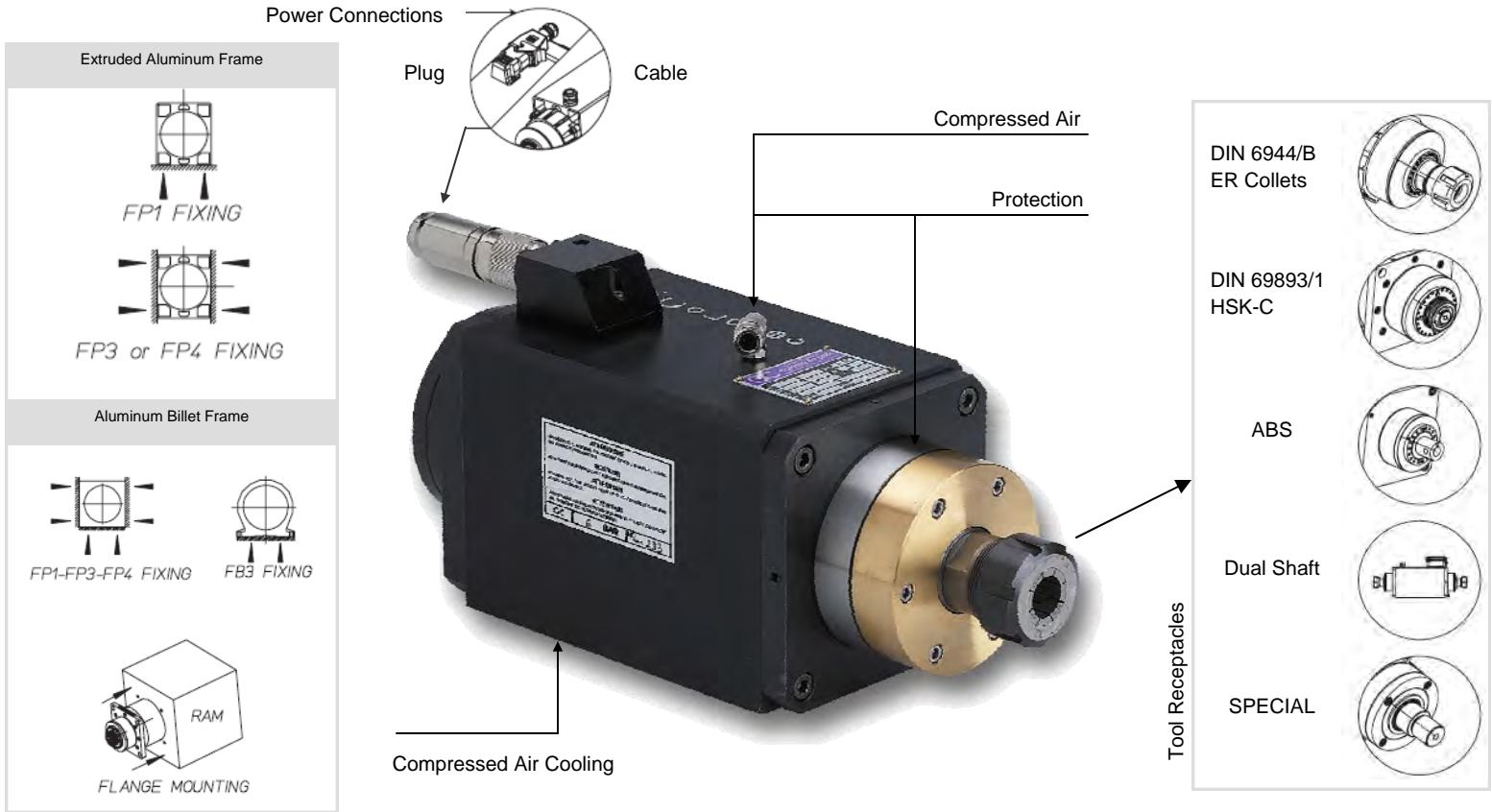

RC and RCE series manual tool change spindles are equipped with a compressed air cooling circuit for applications involving high duty cycles and harsh environments.

The high degree of cooling achieved from the compressed air allows for higher power output with an improved amount of heat dissipation from the rotor - stator unit.

Made from either extruded or machined aluminum closed frames, they achieve a protection rating of IP54 or superior with compressed air pressurization of the front bearing labyrinth seals.

Radial or angular contact bearings (also available with ceramic balls) provide rigidity, stiffness, and the capability of rotation speeds up to 60,000 rpm.

All rotating parts undergo dynamic balancing to stringent levels (residual unbalance values less than G0.4 according to ISO/UNI 1940/1).

MODEL	HP RANGE		RPM RANGE	WEIGHT (LBS)	TOOL RECEPTACLE	
	S1 DUTY 100%				DIN 6499/B ER COLLETS	DIN 69893-1 HSK-C
<b>RC42</b>	0.15 - 0.9		3,000 - 60,000	4 - 7	ER11	
<b>RC55</b>	0.5 - 1.75		3,000 - 60,000	9 - 11	ER11	
<b>RC73</b>	0.7 - 4		3,000 - 40,000	22 - 31	ER20	HSK 32C
<b>RC90</b>	3 - 8		3,000 - 40,000	22 - 53	ER25 / ER32	HSK 40C
<b>RC110</b>	5 - 12		3,000 - 30,000	53 - 62	ER25 / 32 / 40	HSK 40C / 50C
<b>RC120</b>	5 - 16		3,000 - 24,000	51 - 80	ER32 / ER40	HSK 40C / 50C
<b>RC135</b>	8 - 24		3,000 - 24,000	75 - 92	ER32 / ER40	HSK 50C / 63C

• Available in 2 pole or 4 pole. Single voltage and dual voltage configurations available. (ex. 220/380 or 230/460)

# RA SERIES

# Chilled Liquid Cooled - MTC

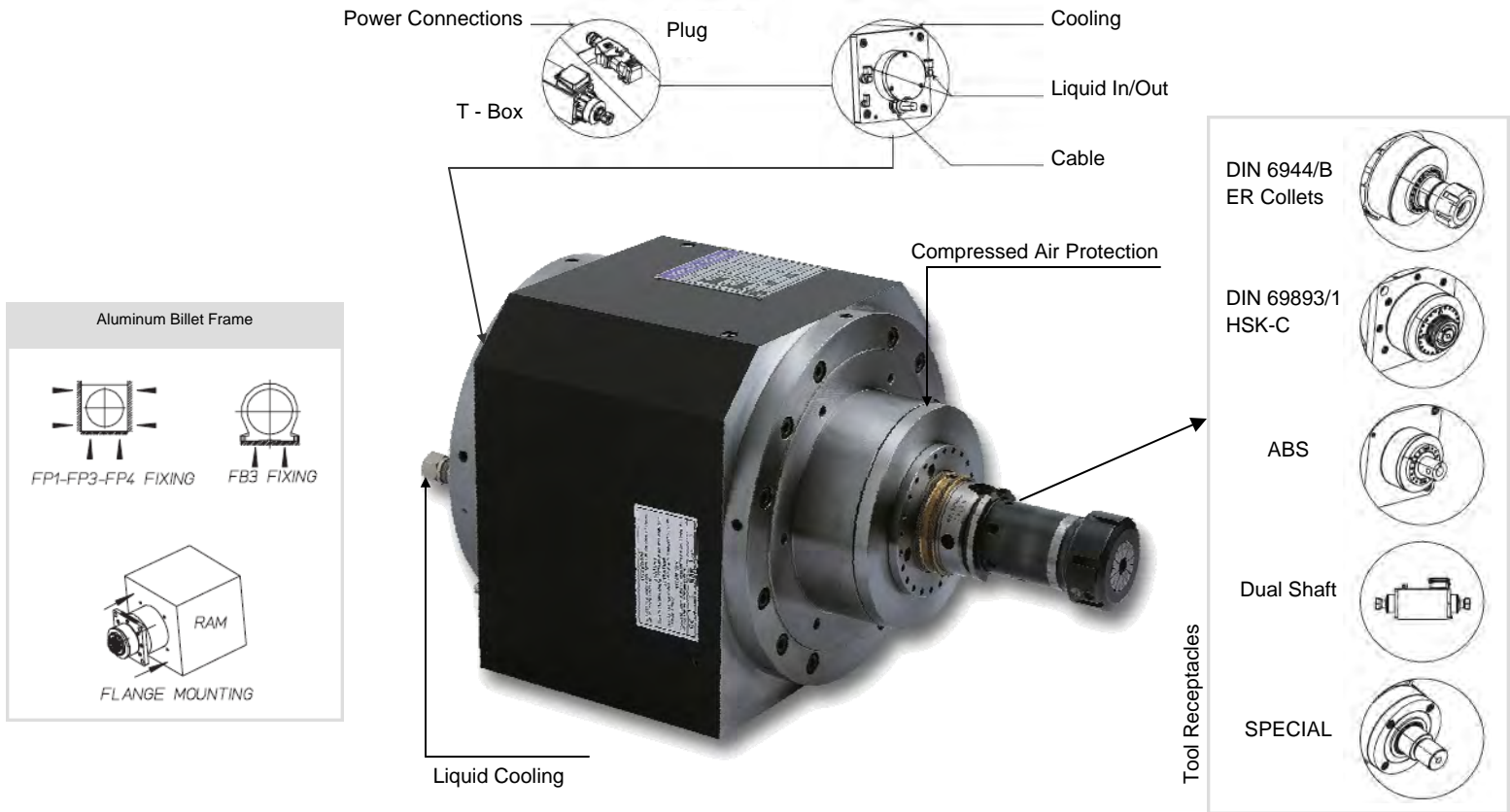

RA series manual tool change spindles are equipped with a chilled liquid cooling circuit for applications involving high duty cycles and harsh environments.

The highest power for a given frame size is achieved in liquid cooled spindles due to the ability of the liquid cooling system to efficiently remove heat from the rotor/stator unit.

Machined from a solid aluminum billet, they achieve a protection rating of IP54 or superior with compressed air pressurization of the front bearing labyrinth seals.

Radial or angular contact bearings (also available with ceramic balls) provide rigidity, stiffness, and the capability of rotation speeds up to 60,000 rpm.

All rotating parts undergo dynamic balancing to stringent levels (residual unbalance values less than G0.4 according to ISO/UNI 1940/1).

MODEL	HP RANGE	RPM RANGE	WEIGHT ( LBS )	TOOL RECEPTACLE	
	S1 DUTY 100%			DIN 6499/B ER COLLETS	DIN 69893-1 HSK-C
<b>RA55</b>	0.5 - 1.75	3,000 - 60,000	9 - 11	ER11	
<b>RA73</b>	0.7 - 4	3,000 - 40,000	22 - 33	ER20	HSK 32C
<b>RA90</b>	3 - 8	3,000 - 40,000	26 - 55	ER25 / ER32	HSK 40C
<b>RA110</b>	5 - 12	3,000 - 30,000	53 - 62	ER25 / 32 / 40	HSK 40C / 50C
<b>RA120</b>	5 - 20	3,000 - 24,000	51 - 80	ER32 / ER40	HSK 40C / 50C
<b>RA135</b>	8 - 40	3,000 - 24,000	79 - 99	ER32 / ER40	HSK 50C / 63C
<b>RA200</b>	10 - 24	3,000 - 18,000	176 - 187	ER40 / ER50	HSK 63C
<b>RA240</b>	32 - 40	3,000 - 9,000	198 - 286	ER40 / ER50	HSK 63C

- Available in 2 pole or 4 pole. Single voltage and dual voltage configurations available. (ex. 220/380 or 230/460)

# ELECTRIC SPINDLES

*Equipped with automatic tool change system - (ATC)*



**PDS Colombo automatic tool change electric spindles** are designed for applications for machines in wood working, plastics, aluminum, light alloys, steel, stone, marble, and glass. In particular, the RA series liquid cooled spindles are suitable for heavy duty applications. Therefore, they are mainly used for light steel, granite, marble and aluminum working as well as plastic and wood.

The wide range of power (from 0.4 HP to 40 HP), with rotating speeds up to 40,000 RPM, allow for the flexibility of use in many different applications.

The **spindle housing** is made from either an extruded aluminum bar, heat treated—special alloy aluminum ingot, or cast aluminum.

The **spindle bearings** are precision angular contact type bearings, with either steel or ceramic balls and they are lubricated for life with special grease designed for high speeds.

GC automatic tool change spindles are available with the following tool changing systems: ISO15, ISO20, ISO25, ISO30, ISO40, and HSK25, HSK32, HSK40, HSK50, HSK63, HSK80.

<b>Series</b>	<b>Description</b>
RV	Air Cooled by Fan (not included)
RS	Air Cooled by attached Electric Fan
RC	Compressed Air Cooled
RA	Liquid Cooled

# RV SERIES

# Air Cooled with Separate Fan or Venturi - ATC

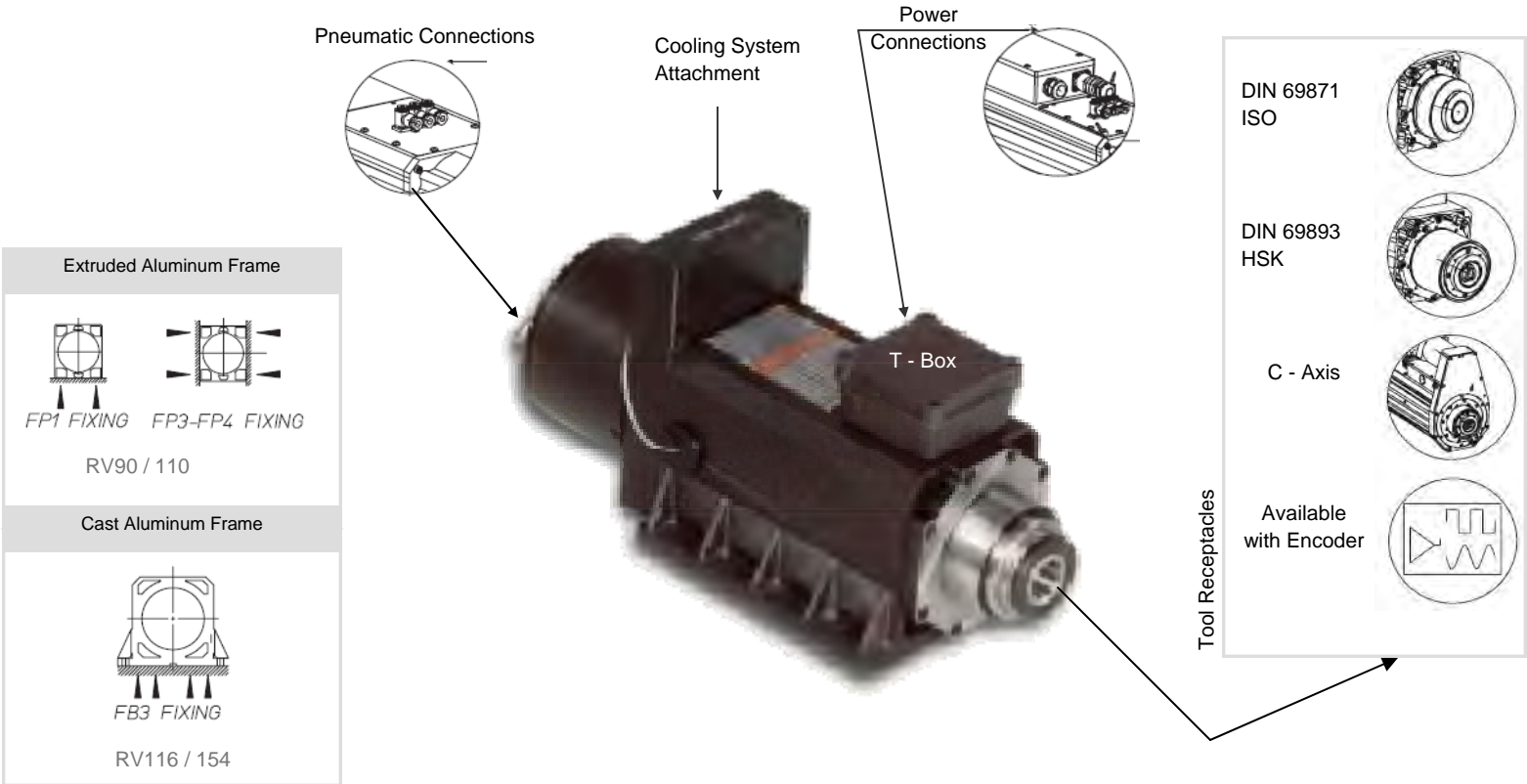

For use in woodworking, plastic, and light alloy machines, RV series automatic tool change spindles allow the user to decide how to cool the spindle. Typical configurations involve mounting an external fan or a compressed air amplifier systems (Venturi).

Available in both ISO - DIN69871 and HSK - DIN69893 clamping systems and equipped with independently balanced clamping systems. The toolholders are retained by special springs and they are released by a pneumatic cylinder. Proximity sensors are incorporated to insure maximum safety and control of the tool change.

Made with an extruded or cast aluminum housing, they achieve a protection rating of IP54 or superior with compressed air pressurization of the front bearing labyrinth seals.

ABEC7 or ABEC9 angular contact bearings (also available with ceramic balls) provide rigidity, stiffness, and the capability of rotation speeds up to 24,000 rpm.

All rotating parts undergo dynamic balancing to stringent levels (residual unbalance values less than G0.4 according to ISO/UNI 1940/1).

MODEL	HP RANGE	RPM RANGE	WEIGHT ( LBS )	TOOL RECEPTACLE	
	S1 DUTY 100%			DIN 69871	DIN 69893 FORM A-B-E-F
<b>RV90</b>	3-5.5	3,000 - 24,000	37	ISO 25	
<b>RV110</b>	3 - 10	3,000 - 24,000	54	ISO 30	HSK 50
<b>RV116</b>	3 - 10	3,000 - 24,000	66	ISO 30	HSK 50 / 63
<b>RV154</b>	7 - 16	3,000 - 24,000	110	ISO 30 / ISO 40	HSK 50 / 63

- Available in 2 pole or 4 pole. Single voltage and dual voltage configurations available. (ex. 220/380 or 230/460)

# RS SERIES

# Air Cooled with Independent Electric Fan - ATC

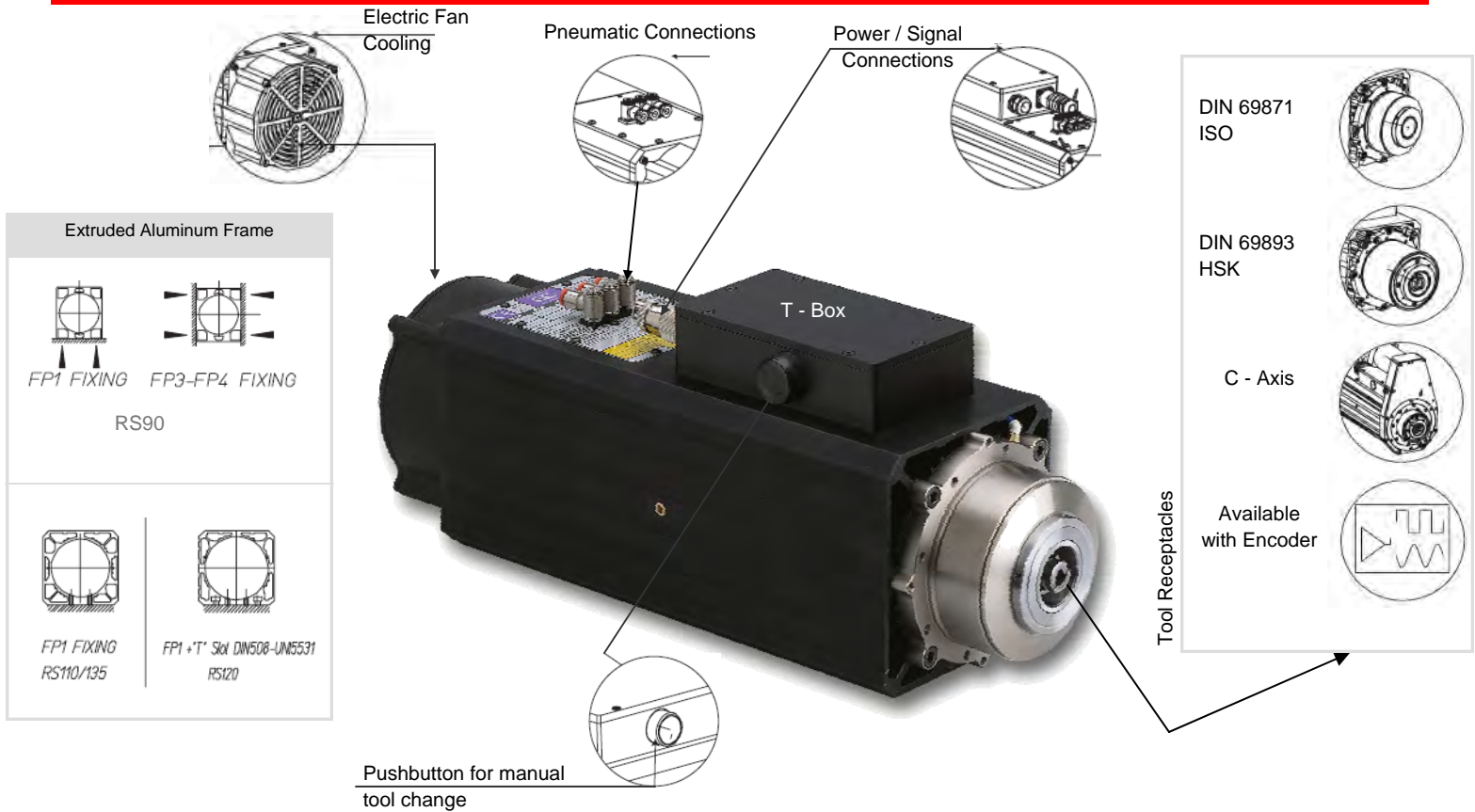

For use in woodworking, plastic, and light alloy machines, RS series automatic tool change spindles are equipped with an independent electric fan mounted directly to the spindle housing. This solution provides the proper air flow for cooling at any speed (even when not rotating) and a very low noise dB rating.

Available in both ISO - DIN69871 and HSK - DIN69893 clamping systems and equipped with independently balanced clamping systems. The toolholders are retained by special springs and they are released by a pneumatic cylinder. Proximity sensors are incorporated to insure maximum safety and control of the tool change.

Made with an extruded aluminum housing, they achieve a protection rating of IP54 or superior with compressed air pressurization of the front bearing labyrinth seals.

ABEC7 or ABEC9 angular contact bearings (also available with ceramic balls) provide rigidity, stiffness, and the capability of rotation speeds up to 24,000 rpm.

All rotating parts undergo dynamic balancing to stringent levels (residual unbalance values less than G0.4 according to ISO/UNI 1940/1).

Available Options: Integrated Encoder for shaft rotation and speed control and C-Axis for 4th axis machining with aggregate heads

MODEL	HP RANGE	RPM RANGE	WEIGHT ( LBS )	TOOL RECEPTACLE	
	S1 DUTY 100%			DIN 69871	DIN 69893 FORM A-B-E-F
<b>RS90</b>	3 - 5.5	12,000 - 24,000	43	ISO 30	HSK 50 / 63
<b>RS110</b>	3 - 11	3,000 - 24,000	55	ISO 30	HSK 50 / 63
<b>RS120</b>	3 - 13.6	3,000 - 24,000	66	ISO 30	HSK 50 / 63
<b>RS135</b>	5.5 - 18	3,000 - 24,000	93	ISO 30 / ISO 40	HSK 50 / 63

- Available in 2 pole or 4 pole. Single voltage and dual voltage configurations available. (ex. 220/380 or 230/460)

# RC SERIES

# Compressed Air Cooled - ATC



RC series automatic tool change spindles are equipped with a compressed air cooling circuit for applications involving high duty cycles and harsh environments. The completely enclosed housing allows for increased protection of the internal components of the spindle in extreme environments.

Available in both ISO - DIN69871 and HSK - DIN69893 clamping systems and equipped with independently balanced clamping systems. The toolholders are retained by special springs and they are released by a pneumatic cylinder. Proximity sensors are incorporated to insure maximum safety and control of the tool change.

Made with a machined aluminum housing, they achieve a protection rating of IP54 or superior with compressed air pressurization of the front bearing labyrinth seals to protect internal parts from contamination.

ABEC7 or ABEC9 angular contact bearings (also available with ceramic balls) provide rigidity, stiffness, and the capability of rotation speeds up to 40,000 rpm.

All rotating parts undergo dynamic balancing to stringent levels (residual unbalance values less than G0.4 according to ISO/UNI 1940/1).

Available Options: Integrated Encoder for shaft rotation and speed control and C-Axis for 4th axis machining with aggregate heads. Also available with through the shaft tool coolant on some models.

MODEL	HP RANGE		RPM RANGE	WEIGHT ( LBS )	TOOL RECEPTACLE	
	S1 DUTY 100%				DIN 69871	DIN 69893 FORM A-B-E-F
<b>RC55</b>	0.4 - 1.5		12,000 - 40,000	14.5	ISO 15	HSK 25
<b>RC73</b>	1.5 - 3		12,000 - 40,000	21	ISO 20	HSK32 / 40
<b>RC90</b>	4 - 5.5		9,000 - 32,000	40	ISO 25	HSK 40 / 50
<b>RC110</b>	3 - 11.8		3,000 - 32,000	62	ISO 30	HSK 50 / 63
<b>RC120</b>	1 - 14.75		1,500 - 24,000	87	ISO 30	HSK 50 / 63
<b>RC135</b>	3 - 20		1,500 - 24,000	132	ISO 30 / ISO 40	HSK 50 / 63 / 80

- Available in 2 pole or 4 pole. Single voltage and dual voltage configurations available. (ex. 220/380 or 230/460)

# RA SERIES

# Chilled Liquid Cooled - ATC

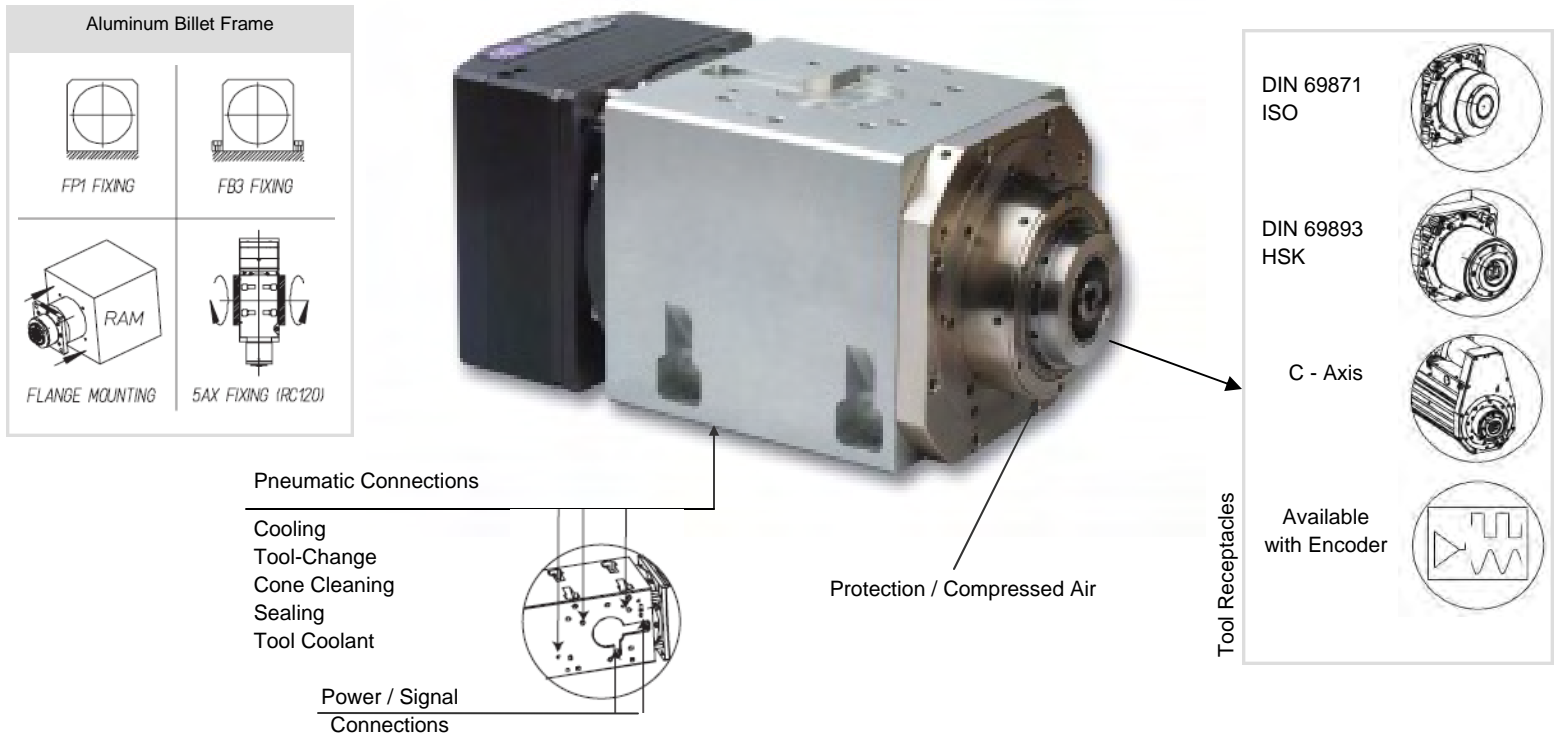

RA series automatic tool change spindles are equipped with a chilled liquid cooling circuit for applications involving high duty cycles and harsh environments. The completely enclosed housing allows for increased protection of the internal components of the spindle in extreme environments- such as metal or stone working. The highest power for a given frame size is achieved in liquid cooled spindles due to the ability of the liquid cooling system to efficiently remove heat from the rotor/stator unit.

Available in both ISO - DIN69871 and HSK - DIN69893 clamping systems and equipped with independently balanced clamping systems. The toolholders are retained by special springs and they are released by a pneumatic cylinder (hydraulic cylinder for stone spindles). Proximity sensors are incorporated to insure maximum safety and control of the tool change.



Made with a machined aluminum housing, they achieve a protection rating of IP54 or superior with compressed air pressurization of the front bearing labyrinth seals to protect internal parts from contamination. Stone and metal spindles also have a niplay coating on many components to protect against corrosion. ABEC7 or ABEC9 angular contact bearings (also available with ceramic balls) provide rigidity, stiffness, and the capability of rotation speeds up to 40,000 rpm. All rotating parts undergo dynamic balancing to stringent levels (residual unbalance values less than G0.4 according to ISO/UNI 1940/1).

Available Options: Integrated Encoder for shaft rotation and speed control and C-Axis for 4th axis machining with aggregate heads. Also available with through the shaft tool coolant on some models.

MODEL	HP RANGE		RPM RANGE	WEIGHT (LBS)	TOOL RECEPTACLE	
	S1 DUTY 100%				DIN 69871	DIN 69893 FORM A-B-E-F
<b>RA55</b>	0.4 - 1.5		12,000 - 40,000	16.5	ISO 15	HSK 25
<b>RA73</b>	1.5 - 3		12,000 - 40,000	24	ISO 20	HSK32 / 40
<b>RA90</b>	4 - 5.5		9,000 - 32,000	44	ISO 25	HSK 40 / 50
<b>RA110</b>	3 - 11.8		3,000 - 32,000	66	ISO 30	HSK 50 / 63
<b>RA120</b>	1.5 - 20		1,500 - 24,000	68	ISO 30	HSK 50 / 63
<b>RA135</b>	3 - 29.5		1,500 - 24,000	139	ISO 30 / ISO 40	HSK 50 / 63 / 80
<b>RA150</b>	10 - 40		3,000 - 15,000	158	ISO 40	HSK 63 / 80
<b>RA170</b>	14.75 - 47		3,000 - 12,000	242	ISO 40	HSK 63 / 80
<b>RA200</b>	20 - 47		3,000 - 12,000	220	ISO 40	HSK 63 / 80

• Available in 2 pole or 4 pole. Single voltage and dual voltage configurations available. (ex. 220/380 or 230/460)

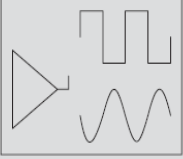
# BI-ROTATING HEADS

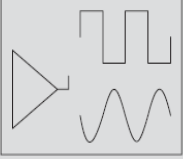
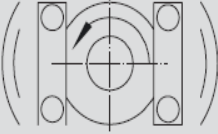
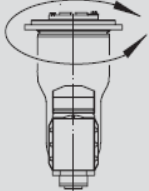
OPTIONS	INDEX 20				COMPACT			
 <p>Spindle Encoder Available</p>								
 <p>Axis Encoder Available</p>								
 <p>Axis Brake Available</p>	<p>Two Axis head with “inverted L style” housing. The Index 120 is suitable for machines used in wood-working, light alloys, and composites (fiberglass, carbon-fiber). Motion transmission of the head is through Yaskawa servomotors (equipped with integrated encoders). Spindle available with HSK-63F (DIN 69893) or ISO30 tool clamping.</p>				<p>Two Axis head with compact “inverted L style” housing. The Compact series offers reduced “C” axis overall size and reduced distance from the mounting flange to the spindle nose. The COMPACT head is suitable for machines used in wood-working, light alloys, and composites (fiberglass, carbon-fiber). Motion transmission of the head is through Yaskawa servomotors (equipped with integrated encoders). Spindle available with HSK-63F (DIN 69893) or ISO30 tool clamping.</p>			
 <p>Continuous Rotation Available</p>								
	Technical Characteristics				Technical Characteristics			
HEAD	C - Axis		A - Axis		C - Axis		A - Axis	
AXIS ROTATION	±225°		±100°		±225°		±100°	
MAX SPEED (continuous)	72°/sec (3000 rpm)		72°/sec (3000 rpm)		80°/sec (3000 rpm)		80°/sec (3000 rpm)	
MAX SPEED (positioning)	119°/sec (3000 rpm)		119°/sec (3000 rpm)		135°/sec (3000 rpm)		135°/sec (3000 rpm)	
MAX TORQUE (continuous)	300 Nm		140 Nm		450 Nm		300 Nm	
MAX TORQUE (non-cont.)	370 Nm		220 Nm		650 Nm		420 Nm	
ELECTRIC SPINDLE								
SPEED (RPM)	12,000	15,000	18,000	24,000	12,000	15,000	18,000	24,000
POWER (HP)	14.75	14.75	10.7	9	14.75	14.75	10.7	9
SERVICE TYPE	S1				S1			
TOOL UNCLAMP	Pneumatic - 87 PSI				Pneumatic - 87 PSI			
COOLING	LIQUID				LIQUID			
TOTAL WEIGHT	~ 220 LBS				~ 220 LBS			

OPTIONS	TP	FAST
---------	----	------

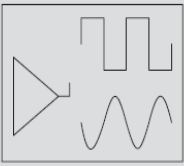

Spindle Encoder Available

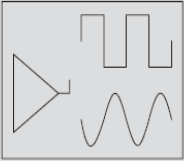

Axis Encoder Available

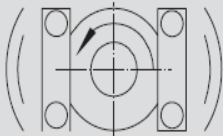

Axis Brake Available

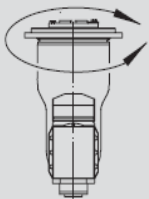

Continuous Rotation Available



Two Axis head with compact “inverted L style” housing. The TP series offers reduced “C” axis overall size and reduced distance from the mounting flange to the spindle nose. The TP is suitable for machines used in light precision machining of plastics or composites (fiberglass, carbon-fiber). Motion transmission of the head is through servomotors (equipped with integrated encoders) with advanced controls for faster working and positioning speeds. Spindles are equipped with ISO 30 automatic tool change and higher rotation speeds up to 30,000 rpm.

Two Axis head with “YOLK” style housing. The FAST head is suitable for machines used in wood-working, light alloys, and composites (fiberglass, carbon-fiber). This 2-Axis head allows for complex machining with superior stiffness enabled by the head’s 2 sided spindle support. Motion transmission of the head is through Yaskawa servomotors (equipped with integrated encoders). Spindle available with HSK-63F (DIN 69893) or ISO30 tool clamping.

HEAD	Technical Characteristics				Technical Characteristics			
	C - Axis		A - Axis		C - Axis		A - Axis	
<b>AXIS ROTATION</b>	±225°		±100°		±225°		±100°	
<b>MAX SPEED (continuous)</b>	100°/sec (3000 rpm)		100°/sec (3000 rpm)		72°/sec (3000 rpm)		72°/sec (3000 rpm)	
<b>MAX SPEED (positioning)</b>	170°/sec (3000 rpm)		170°/sec (3000 rpm)		119°/sec (3000 rpm)		119°/sec (3000 rpm)	
<b>MAX TORQUE (continuous)</b>	200 Nm		140 Nm		300 Nm		260 Nm	
<b>MAX TORQUE (non-cont.)</b>	300 Nm		240 Nm		370 Nm		370 Nm	
<b>ELECTRIC SPINDLE</b>								
<b>SPEED (RPM)</b>	12,000	15,000	18,000	24,000**	9,000	12,000	18,000	24,000
<b>POWER (HP)</b>	6.7	8.5	10	7	16	16	10	5
<b>SERVICE TYPE</b>	S1				S1			
<b>TOOL UNCLAMP</b>	Pneumatic - 175 PSI				Pneumatic - 87 PSI			
<b>COOLING</b>	LIQUID				LIQUID			
<b>TOTAL WEIGHT</b>	~ 198 LBS				~ 220 LBS			

\*\* TP series also available with speeds up to 30,000 RPM (8 HP)

# MECHANICAL SPINDLES

## SAT14 SERIES

## Self Cooled Mechanical Drive Spindle - ATC

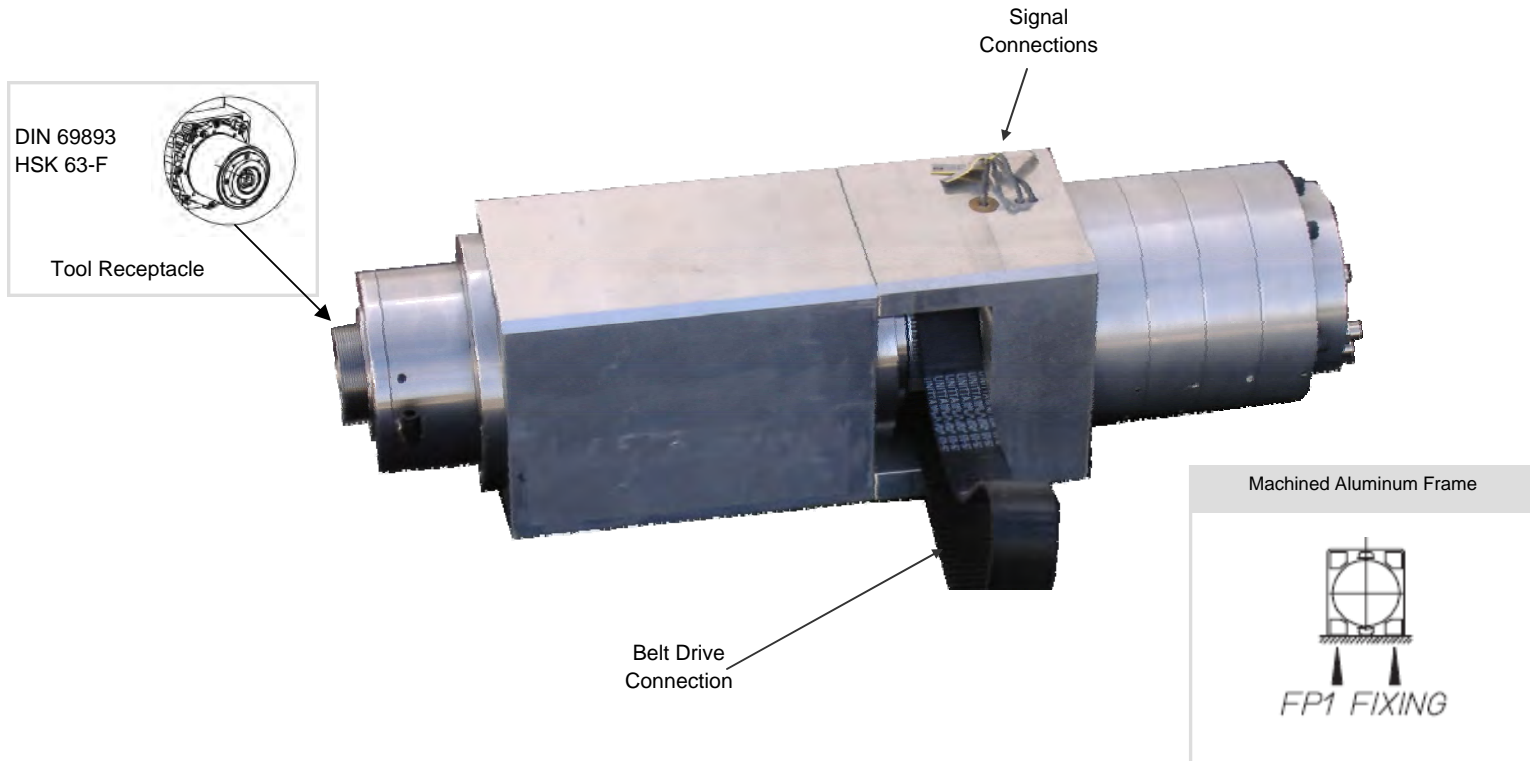

For use in woodworking, plastic, and light alloy machines, SAT series automatic tool change mechanical spindles are ideal for low speed - high torque applications such as shaping, sanding, moulding, grinding and polishing.

Available in HSK - DIN69893 clamping systems and equipped with independently balanced clamping systems. The toolholders are retained by special springs and they are released by a pneumatic cylinder. Proximity sensors are incorporated to insure maximum safety and control of the tool change.

### Spindle Specifications

MDR HSK-F 63 10,000 RPM - Belt Drive Spindle  
Dwg #AT14-S10-H6F

#### FEATURES:

- Natural air cooling
- Double acting pneumatic cylinder
- Air pressure seal of front & rear bearings
- Shaft stop sensor
- Three drawbar sensors with cam locks
- Quick connect plug for sensor connections
- Cone clean
- Tool clamping for HSK-F 63 tapers (DIN 69893-5)
- Top speed: 10,000 RPM
- Dual angular contact bearings front and rear
- Bi-directional mounting holes for left / right mounting
- Dual belt opening for up to 2:1 pulley ratio
- Offset spindle nose to get closer to the workpiece

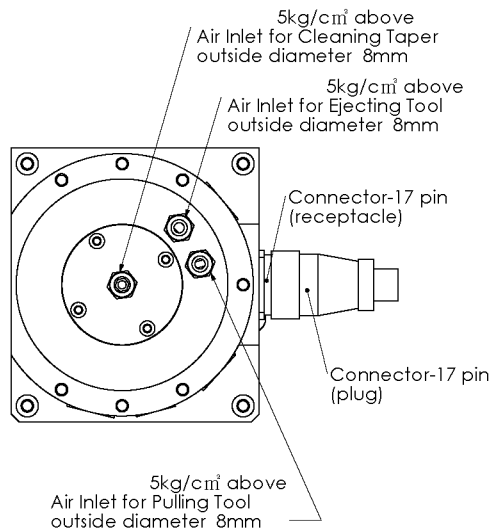

### Offset Spindle Nose



MODEL	HP RANGE	RPM RANGE	WEIGHT ( LBS )	TOOL RECEPTACLE
	S1 DUTY 100%			DIN 69893 FORM A-B-E-F
<b>SAT14-S10</b>	0 - 10	0 - 10,000	58	HSK 63 F

# PROCESSING AGGREGATES

## FIXED ANGLE

### Fixed Angle Aggregates with 1, 2, and 4 tool receptacles

Single, dual, and four output aggregates are an affordable way to add horizontal capabilities to your CNC machine. You can perform many operations such as sawing, routing, boring, and mortising. Use single output aggregates when horizontal processes are used in one direction, or use with our C-axis for 360° capability. Use the Dual and Four Output aggregates when processes are needed in more than one direction, or when multiple tools are used such as an end mill and saw blade.



Aggregate Model	N-LINE	X-LINE
Spindle Speed Max	10,000 RPM	10,000 RPM
Tool Speed Max	15,000 PRM	15,000 RPM
Rotation	Aggregate can be rotated 360°	Aggregate can be rotated 360°
Max. Torque	15 ft-lbs	17 ft-lbs
Max. Temperature	185° F	185° F
Tool Outputs	1, 2, or 4	1, 2, or 4
Spindle Direction	Single: Same	Single: Same
	Dual: 1 same/ 1 opposite	Dual: 1 same/ 1 opposite
	Four: 2 same/ opposite	Four: 2 same/ opposite

## VARIABLE

### Variable Angle Aggregates



Variable Angle aggregates can be set to cut at any angle in the given range to perform specialty cuts on your CNC Machine. Our Standard Duty aggregate can swivel 0° to 100° and the Heavy Duty aggregate can swivel from -100° to +100°.

Aggregate Model	N-LINE	X-LINE
Spindle Speed Max	15,000 RPM	13,760 RPM
Tool Speed Max	15,000 PRM	15,000 RPM
Rotation	Aggregate can be rotated 360°	Aggregate can be rotated 360°
Max. Torque	15 ft-lbs	17 ft-lbs
Max. Temperature	185° F	185° F
Spindle Direction	Opposite Machine Spindle	Opposite Machine Spindle
Swiveling Range	0° to 100°	-100° to 100°

# PROCESSING AGGREGATES

## FLOATING

### *Floating Head following aggregate*

The Floating Aggregate Head accurately follows the contours of your stock, automatically compensating for up to 10mm of variance. Floating pressure is adjustable from 1/4 lbs to 20 lbs. The convenient tool pre-setting flange allows you to perform fast, accurate tool changes. Compressed air through the aggregate provides for removal of chips and dust from the aggregate.



Aggregate Model	N-LINE
Spindle Speed Max	18,000 RPM / 24,000 RPM*
Gear Ratio	1 : 1
Rotation	Aggregate can be rotated 360°
Max. Torque	20 ft-lbs
Max. Temperature	185° F
Floating Bell	70 mm deep x 105 mm ID
Spindle Direction	Same as Machine Spindle
Floating Range	10mm
Floating Pressure	Adjustable from 0.25 to 20 lbs

\*24,000 RPM for high speed and/or small cutting tools

## Other Aggregates Available



**Lock Recess Aggregate**



**Horizontal Line Boring Aggregate**



**Underneath Processing Aggregate**

\* Please contact Precision Drive Systems sales to find out the full range of Aggregate types and output receptacles that are available to meet the requirements of your application.

**Rotary C-Axis**

**Convert your existing 3-Axis CNC into a 4-Axis Machine with the C-Axis Unit!**

Features:

- The C-Axis Unit allows continuous 360° rotation of our processing aggregates.
- Position is controlled by a servo motor and 5mm PNP home position sensor.
- Rotary transmission by gears
- Pin receiver to suit 12mm diameter pin with 45mm spacing from centerline
- Models available for 100mm and 120mm spindle nose diameter
- The servo motor is not included with the unit

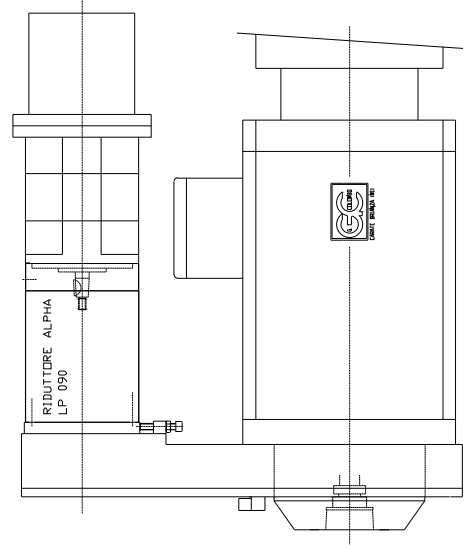

**Anti-Rotation Collar**

The Anti –Rotation collar is designed to fit spindles with 100mm and 120 mm nose diameters. The typical setup for the torque receiver is for aggregates with a 12mm diameter pin and 45 mm spacing from the centerline.

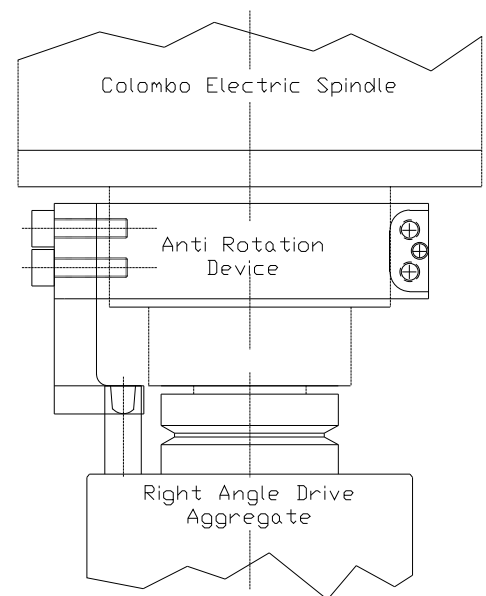
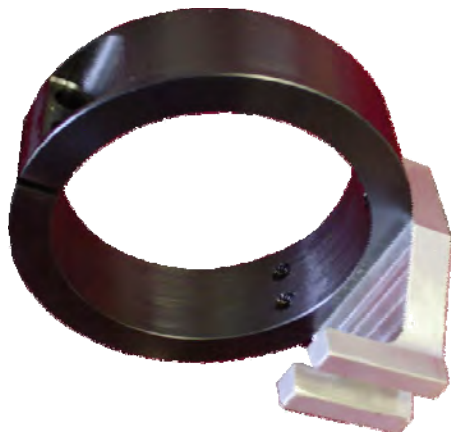

# BORING UNITS

**BU**

## Multi-spindle Drill Units

PDS multi-spindle boring units are designed by our engineers in Germany and manufactured in the United States. These units are belt driven and come standard in the 5 configurations shown. Custom units are also available upon request. Standard spindle center distance is 32 mm and each spindle can be actuated individually.

\*\* 9 Spindle L-Shaped Unit with 2 horizontal spindles pictured below

- Maintenance Free
- Easy Spindle Replacement
- Quiet and Cool Operation
- Same Rotation for all spindles - No left hand tools required.

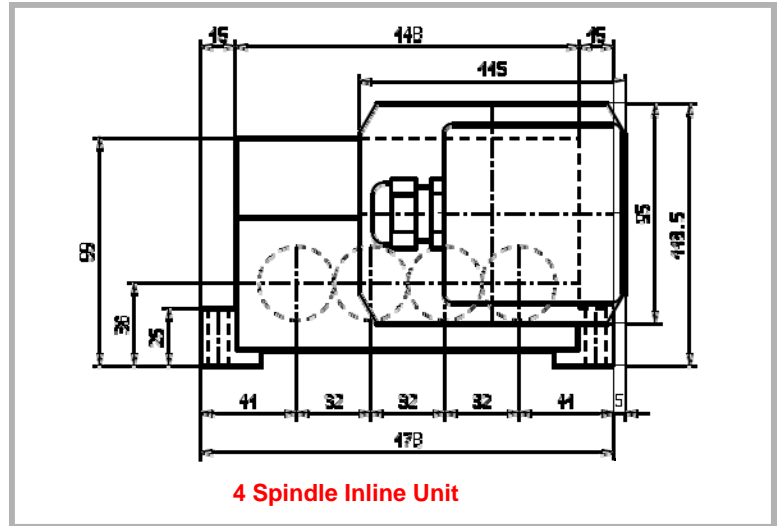
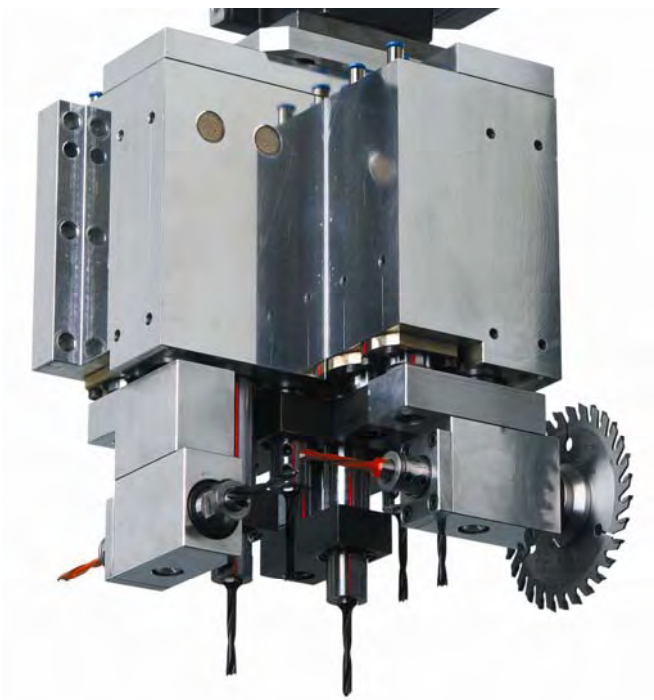

	4 SPINDLE INLINE	7 SPINDLE INLINE	9 SPINDLE L-SHAPE	13 SPINDLE L-	17 SPINDLE L-
Drive Turning Direction	Right Hand	Right Hand	Right Hand	Right Hand	Right Hand
Tool Rotational Direction	4 Equal to Drive	7 Equal to Drive	9 Equal to Drive	13 Equal to Drive	17 Equal to Drive
Drilling Receptacle	4 x 10mm H7	7 x 10mm H7	9 x 10 mm H7	15 x 10 mm H7	19 x 10 mm H7
Motor	1.5 HP	1.5 HP	1.5 HP	3 HP	3 HP
Drive Speed	3,600 RPM	3,600 RPM	3,600 RPM	3,600 RPM	3,600 RPM
Spindle Speed	3,600 RPM	3,600 RPM	Contact PDS	8,000 RPM	8,000 RPM
Stroke	50.0 mm	50.0 mm	50.0 mm	50.0 mm	50.0 mm
Weight	55 lbs	60 lbs	66 lbs	88 lbs	110 lbs

**BU**

*Multi-spindle Drill Units - Drawings*

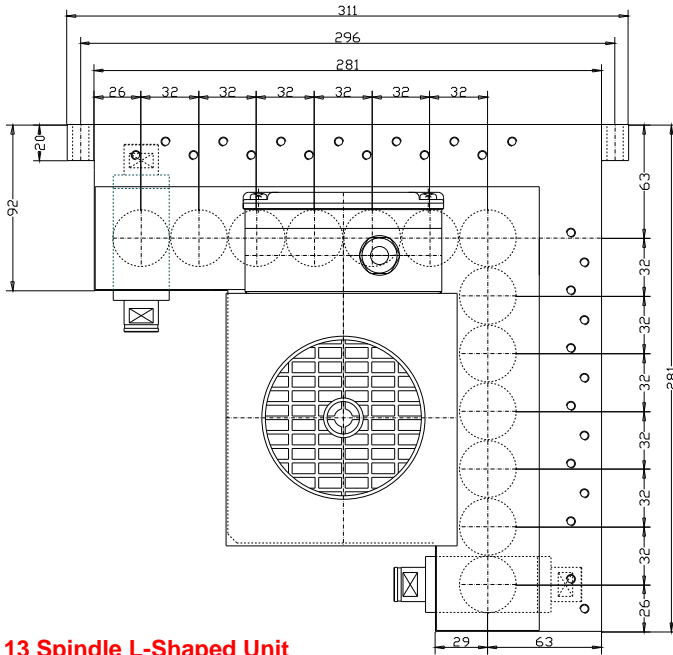

**13 Spindle L-Shaped Unit**

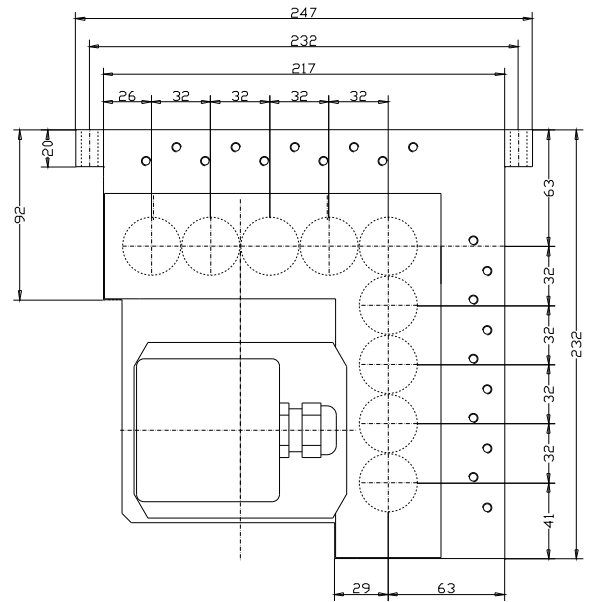

**9 Spindle L-Shaped Unit**

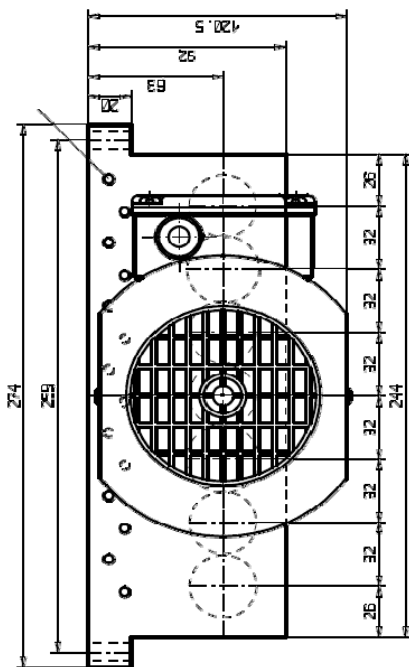

**7 Spindle Inline Unit**

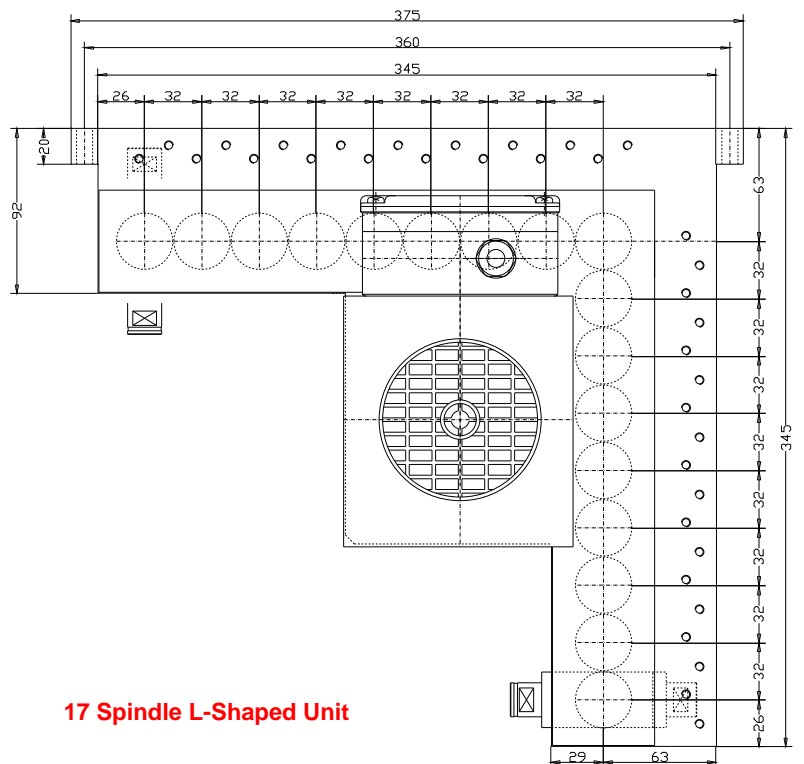

**17 Spindle L-Shaped Unit**

# VARIABLE FREQUENCY DRIVES

VFD - B

Delta B Series Variable Frequency Drives



## DELTA VFD - B SERIES

Since the late 90's, PDS has incorporated Delta VFD's into our spindle packages. The Delta B Series has an easy to use keypad for programming and interfaces well with CNC control systems. This drive is capable of 1,000 HZ for very high speed applications. For small applications up to 3 HP, it is capable of outputting 3-phase power while working from single phase 220 V input.

Control Specification		Control System	SPWM control (V/F or sensorless vector control)
		Output Freq. Range	0.10 ~ 1,000 Hz
		Freq. Setting Resolution	0.01 Hz
		Output Freq. Resolution	0.01 Hz
		PWM Carrier Frequency	Adjustable between 1 and 15 KHz
		Torque Boost	Auto torque, auto slip compensation, start torque: 150% @ 1 Hz
		Skip Frequency	Three zones, settings range 0.1 - 400 Hz
		Accel. / Decel. Time	0.1 to 3600 seconds (4 independent settings for accel./decel. Time)
		Stall Prevention Level	Set current limit from 20% - 250%
		DC Injection Braking	Operation frequency 0 - 1,000 Hz, output 0-100% rated current Start time 0-25 seconds, stop time 0-25 seconds
		Braking Torque	Approx. 20% (up to 125% possible with option braking resistor or braking unit externally mounted, 1-15HP braking transistor built-in)
		V / F Pattern	Adjustable V/F Pattern
Operation Specification		Frequency Setting	Keypad: Set by up/down keys External: -10~+10 VDC, 0~10VDC, 4~20mA DC, communication (RS-485)
		Operation Signals	Keypad: Set by [RUN], [STOP], [JOG] External: Fwd/stop, rev/stop, (run/stop, fwd/rev), 3-wire control, comm. (RS-485)
		Multi-Function Input Terminal	Multi-speed selection 1 to 15, 1st/2nd/3rd/4th accel./decel. time selection Accel./decel. Inhibit, external baseblock, counter applications 15-step process control, disable auxiliary, jog, up/down command, sink/source selection
		Multi-Function Output Terminal	Drive operational, frequency attained signal, zero speed, setting auxiliary Over torque detection, external baseblock detection, counter applications 15-step process control, disable auxiliary, jog, up/down command, sink/source selection
		Analog Output	Select output frequency or current monitor
		Alarm Output Contact	1 Form C contact or open collector output
		Operation Functions	PID control, fan & pump control, momentary power failure restart, AVR, external fault Fault retry, fault reset, 2 S-curves, fault records, frequency limit, digital frequency output, Parameter lockout, PG feedback control, auto tuning, REV run inhibit, stall prevention
		Protective Functions	Overvoltage, overcurrent, under-voltage, external trip, motor overload Ground fault current, overload, overheat, IGBT short-circuit, Low current
		Display Keypads	8-Key, 5-digit, 7-segment LED; 8 status LEDs, master frequency, output frequency, Output current, custom units, parameter values for setup, review and faults, RUN, STOP, RESET, FWD/REV, JOG
Environment		Ambient Temperature	-10C TO +40C (+50C without dust covers)
		Storage Temperature	-20C to +60C
		Pollution Degree	2
		Ambient Humidity	90% RH or less (non-condensing)
		Installation Location	Altitude 1,000 m or less, keep from corrosive gas, liquid and dust
		Vibration	9.81 m/s <sup>2</sup> (1G) less than 20Hz, 5.88 m/s <sup>2</sup> (0.6G) at 20 to 50 Hz

		230 V Series 1-Phase / 3-Phase											460 V Series 3-Phase												
Model VFD ■■■ B		007	015	022	037	055	075	110	150	185	220	300	370	007	015	022	037	055	075	110	150	185	220	300	370
Output	Max. Applicable Motor Output (KW)	0.75	1.5	2.2	3.7	5.5	7.5	11	15	18.5	22	30	37	0.75	1.5	2.2	3.7	5.5	7.5	11	15	18.5	22	30	37
	Max. Applicable Motor Output (HP)	1	2	3	5	7.5	10	15	20	25	30	40	50	1	2	3	5	7.5	10	15	20	25	30	40	50
	Rated Capacity (kVA)	1.9	2.4	4.2	6.5	9.5	12.5	18.3	24.7	28.6	34.3	45.7	55	2.3	3.2	4.2	6.5	9.9	13.7	18.3	24.4	28.9	34.3	45.7	55.6
	Rated Current (A)	5.0	7.0	11	17	25	33	49	65	75	90	120	145	2.7	4.2	5.5	8.5	13	18	24	32	38	45	60	73
Output Frequency Range		0.1 ~ 1,000 Hz											0.1 ~ 1,000 Hz												
Overload Endurance		150% of rated current for 60 seconds											150% of rated current for 60 seconds												
Voltage		Proportional to input voltage											Proportional to input voltage												
Phase • Voltage • Hz		1/3 Phase			3 - Phase • 200~240Vac • 50/60 Hz									3 - Phase • 380~480Vac • 50/60 Hz											
Voltage • Frequency Tolerance		Voltage: ± 10% • Frequency: ± 5%											Voltage: ± 10% • Frequency: ± 5%												
Input	Input Current (A)	11.9 5.7	15.3 7.6	22 15.5	20.6	26	34	50	60	75	90	110	142	3.2	4.3	5.9	11.2	14	19	25	32	39	49	60	63
	Single (3-phase Input Current)	7.0	9.4	14.0																					
Cooling Method		Self		Fan Cooled									Natural			Fan Cooled									
Weight (Kg)		2.7	3.2	4.5	3	8	10	13	13	13	13	36	36	2.7	3.2	4.5	3	8	10	13	13	13	36	36	36

# ACCESSORIES

## PDS TOOLHOLDERS & COLLETS APPLICATION STRATEGY & PERFORMANCE BENEFITS

Item	Feature	Benefit
All Tool holders ISO, BT & HSK	Critical surfaces & threads finished after hardening ensures collet cavity, threads and mounting taper are concentric within 4 microns	<ul style="list-style-type: none"> <li>* Smoother Cuts</li> <li>* Longer Spindle Bearing Life</li> <li>* More Precise Spindle Clamping</li> <li>* Minimizes ISO Taper Sticking</li> </ul>
HSK Tool holders	Finishing after hardening ensures accuracy of relationship held between spindle face, clamping plane and ejection plane.	<ul style="list-style-type: none"> <li>* More Clamping Security &amp; Reliability</li> <li>* More Reliable Automatic Tool Change</li> </ul>
Collet Lock Nuts With Ball Bearings	Reduced friction provides higher clamping torque capacity with no collet distortion	<ul style="list-style-type: none"> <li>* Improves accuracy for smoother cuts</li> <li>* Extends normal tool life</li> <li>* Suitable for diamond tooling</li> </ul>
Optional ER Series Ultra Precision Collets	Assembled accuracy within 6 microns T.I.R.	<ul style="list-style-type: none"> <li>* Smoother cuts</li> <li>* Longer normal tool life</li> <li>* Longer Diamond tool life</li> </ul>
OZ 25 & OZ 16 Collets (Available in Ultra Precision)	Double the clamping torque capacity using steeper clamping taper geometry	<ul style="list-style-type: none"> <li>* Eliminates tool slip</li> <li>* Extends tool life</li> <li>* Replaces Hydra-lock chucks at half the cost &amp; less vulnerable to damage</li> </ul>

### ISO AND HSK COLLET CHUCKS



Part Number	Clamping Systems	Collet Type
<b>TH-ISO15 / ER11M</b>	ISO 15	ER11 (MINI NUT)
<b>TH-ISO20 / ER16M</b>	ISO 20	ER16 (MINI NUT)
<b>TH-ISO20 / ER20M</b>	ISO 20	ER20 (MINI NUT)
<b>TH-ISO25 / ER25E</b>	ISO 25	ER25
<b>TH-ISO30 / ER32-F</b>	ISO 30 - COLOMBO FINGERS	ER32
<b>TH-ISO30 / ER32-B</b>	ISO 30 - COLOMBO BALLS	ER32
<b>TH-ISO30 / ER32-H50</b>	ISO30 - HSD STYLE	ER32
<b>TH-HSK50F / ER32</b>	HSK 50 -FORM F	ER32
<b>TH-HSK63F / ER32</b>	HSK 63 -FORM F	ER32
<b>TH-HSK63F / ER40</b>	HSK 63 -FORM F	ER40
<b>TH-HSK63F / OZ25</b>	HSK 63 -FORM F	OZ25

\*\* Standard stock toolholders listed above. Please contact PDS for inquiries regarding specials.

### ER AND OZ COLLETS

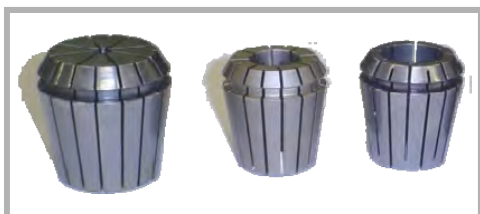

ER11 - ER40, OZ20 - OZ25  
Inch & Metric Shank Sizes

### COLLET NUTS



Bearing Style, Mini & Standard ER Collet Nuts

### COLLET AND SHAFT WRENCHES

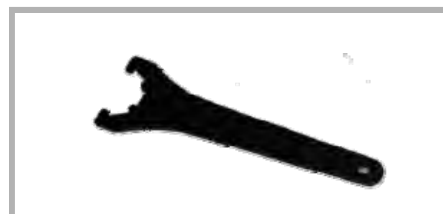

Standard ER & Mini Nut Wrenches, Open  
End Shaft Wrenches, Bearing Nut Spanners,  
Torque Keys



***Precision Drive Systems, LLC***

**PRECISION DRIVE SYSTEMS, LLC.**  
4367 DALLAS CHERRYVILLE HIGHWAY  
BESSEMER CITY, NC 28016 USA

PHONE: 704.922.1206  
MAIN FAX: 704.922.1217  
SALES FAX: 704.922.9745  
REPAIR / TECH. FAX 704.922.1547

**PDS-GmbH**  
Alter Kirchweg 1  
D-32584 Löhne / Bad Oyenhausen  
Deutschland

PHONE: +49 (0) 57 31 / 74 48 89-0  
FAX: +49 (0) 57 31 / 74 48 89-20